

# RFF500/600/700 Series



24 Vin and 48 Vin single output

DC-DC CONVERTERS 500 W, 600 W and 700 W Full-Brick

1

NEW Product

- High efficiency topology
- Wide temperature range, -40 °C to +100 °C @ full power
- High power density (127 W/in<sup>3</sup>)
- Input voltage range: 18 Vdc to 36 Vdc or 36 Vdc to 75 Vdc
- Output voltage range: 16.8 Vdc to 29.4 Vdc
- Remote ON/OFF
- Operational insulation system
- RoHS compliant



RFF500/600/700 series is a high efficiency, enclosed, isolated dc-dc converter series in an industry standard full-brick package that provides up to 700 W of output power. The series delivers very high usable output power for today's high performance RF power amplifier and similar applications. The five models in the series feature an input voltage range of 18 Vdc to 36 Vdc and 36 Vdc to 75 Vdc and an output voltage of 28 V. The output voltage is adjustable from 16.8 Vdc to 29.4 Vdc (not to exceed 500 W for the RFF500, 600 W for the RFF600 and 700 W for the RFF700). The series also has a remote isolated ON/OFF capability. Overcurrent, overvoltage and overtemperature protection features are included as standard. Other options are also available. Full international safety approval including EN/IEC60950-1 VDE and UL/cUL60950 reduces compliance costs and time to market.



2 YEAR WARRANTY

All specifications are typical at nominal input, full load at 25 °C unless otherwise stated. External output capacitance required (See Note 4)

## SPECIFICATIONS

### ABSOLUTE MAXIMUM RATINGS

Input voltage - peak (100 ms max., 1 % duty cycle max.)	24 Vin 48 Vin	-0.5-50 Vdc -0.5-100 Vdc
Input voltage continuous	24 Vin 48 Vin	-0.5-40 Vdc -0.5-80 Vdc
Adjust pin voltage	With respect to -Sense pin	-0.5-12 Vdc

### OUTPUT SPECIFICATIONS

Voltage adjustability	16.8-29.4 Vdc	
Min./max. load	RFF500 RFF600 RFF700	0/17.9 A 0/21.4 A 0/25 A
Output load capacitance	(See Note 3)	330-3,300 µF
Rise time	(See Note 5)	5 ms typ.

### INPUT SPECIFICATIONS

Input current @ Io max. (See Note 1)	24/48 Vin RFF500 24/48 Vin RFF600 48 Vin RFF700	39.7 A/19 A max. 47.6 A/22.8 A max. 26.6 A max.
Input reflected ripple (See Note 2)	24 Vin RFF500/600 48 Vin RFF500/600/700	6 mA (pk-pk) 4 mA (pk-pk)
Input capacitance - Internal filter	24 Vin 48 Vin	66 µF 20 µF
Inrush current	(See Note 4)	2 A <sup>2</sup> s

### EMC CHARACTERISTICS

Conducted emissions	EN55022	See Application Note 174
Radiated emissions	EN55022	See Application Note 174

### GENERAL SPECIFICATIONS

Efficiency	24 Vin	90 %
Vin=Vin (nom), Iout (max)	48 Vin	91 %
Approvals and standards	VDE IEC60950-1 IECEE CB, UL/cUL60950	
Material Flammability	UL94V-0	
Weight	0.5 inch tall version	220 g (7.75 oz.)
MTBF @ 55 °C	Telcordia SR-332 RFF600-24 RFF700-48	Issue 1 1,166,553 hours 1,604,279 hours

### ENVIRONMENTAL SPECIFICATIONS

Thermal performance	Operating baseplate, -40 °C to +100 °C temperature
	Non-operating -40 °C to +100 °C

### ON/OFF PINS ELECTRICAL INTERFACE

(See Application Note 174 for details of the remote ON/OFF)

### International Safety Standard Approvals



VDE0805/EN60950/IEC950 File No. 10401-3336-0198  
Licence No. 40005395



UL/cUL CAN/CSA 22.2 No. 60950  
UL 60950 File No. 135734

# RFF500/600/700 Series

24 Vin and 48 Vin single output

DC-DC CONVERTERS | 500 W, 600 W and 700 W Full-Brick

2

For the most current data and application support visit [www.artesyn.com/powergroup/products.htm](http://www.artesyn.com/powergroup/products.htm)

NEW Product

OUTPUT POWER (MAX.)	INPUT VOLTAGE	OUTPUT VOLTAGE	OUTPUT CURRENT (MIN.)	OUTPUT CURRENT (MAX.)	EFFICIENCY (TYP.)	REGULATION		MODEL NUMBER <sup>(6,7)</sup>
						LINE	LOAD	
500 W	18-36 Vdc	16.8-29.4 Vdc	0 A	17.9 A	90 %	±0.54 %	±0.2 %	RFF500-24S28Y
500 W	36-75 Vdc	16.8-29.4 Vdc	0 A	17.9 A	91 %	±0.54 %	±0.2 %	RFF500-48S28Y
600 W	18-36 Vdc	16.8-29.4 Vdc	0 A	21.4 A	90 %	±0.54 %	±0.2 %	RFF600-24S28Y
600 W	36-75 Vdc	16.8-29.4 Vdc	0 A	21.4 A	91 %	±0.54 %	±0.2 %	RFF600-48S28Y
700 W	36-75 Vdc	16.8-29.4 Vdc	0 A	25 A	91 %	±0.54 %	±0.2 %	RFF700-48S28Y

## Part Number System with Options

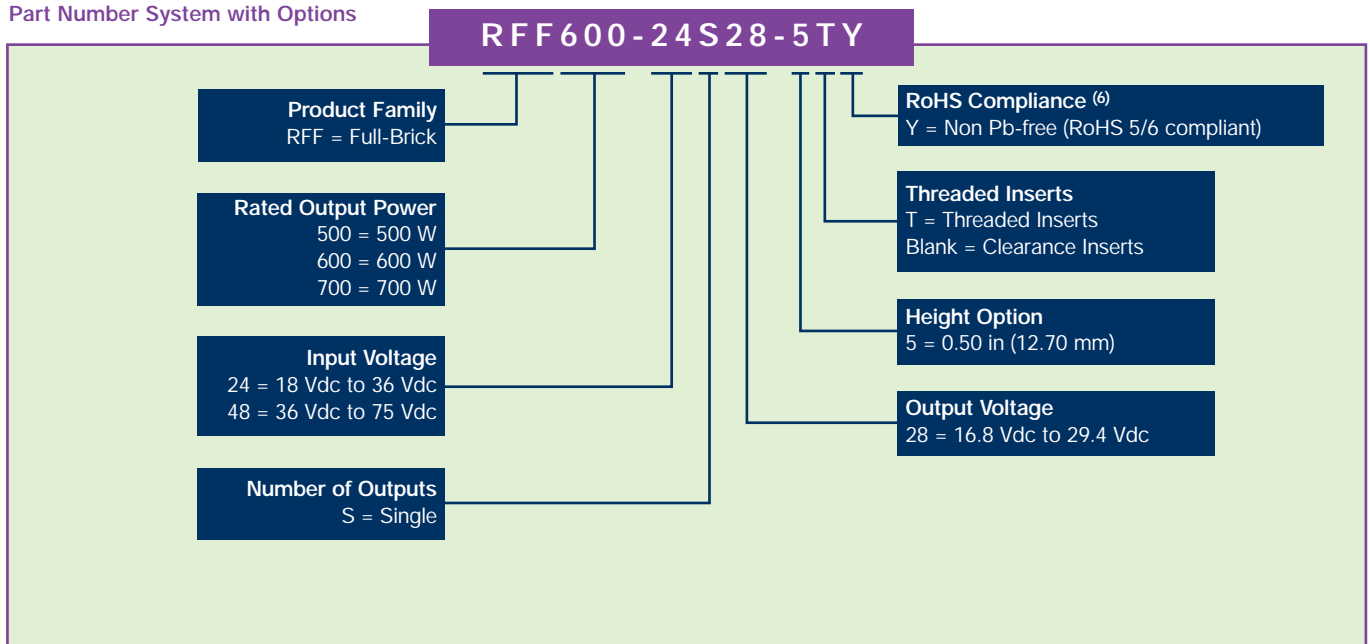

## Notes

- External input fusing required. Use a fast acting fuse: 80 A (24 V model), 40 A (48 V model).
- $I_{out} = I_{out(max)}$  Measured with the input capacitor,  $C_{bypass} = 330 \mu F$ , and  $6 \mu H$  inductor in series with the power source. Frequencies  $>100$  kHz.
- Minimum effective ESR is  $1 m\Omega$ . Minimum phase margin is  $35^\circ$ .
- Measured per ETSI 300 132-2 Section 4.7.2.
- From 10% to 90% of  $V_{out(nom)}$ . Full resistive load.  $1 \mu F$  ceramic and  $330 \mu F$  electrolytic capacitors across the output.
- The 'Y' suffix indicates that these parts are TSE RoHS 5/6 (non-Pb-free) compliant.
- NOTICE: Some models do not support all options. Please contact your local Artesyn representative or use the on-line model number search tool at <http://www.artesyn.com/powergroup/products.htm> to find a suitable alternative.

## PROTECTION

Short-circuit (Brickwall current limiting)	RFF500	21 A
	RFF600	25.2 A
	RFF700	29.4 A
Overtemperature shutdown	Output shutdown	33.2 V
Overtemperature shutdown	Midpoint of baseplate	110 °C

# RFF500/600/700 Series

24 Vin and 48 Vin single output

DC-DC CONVERTERS | 500 W, 600 W and 700 W Full-Brick

3

For the most current data and application support visit [www.artesyn.com/powergroup/products.htm](http://www.artesyn.com/powergroup/products.htm)

NEW Product

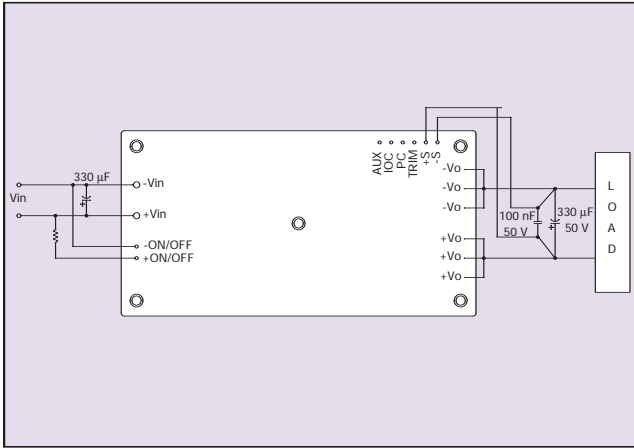

Figure 1 - Standard Application

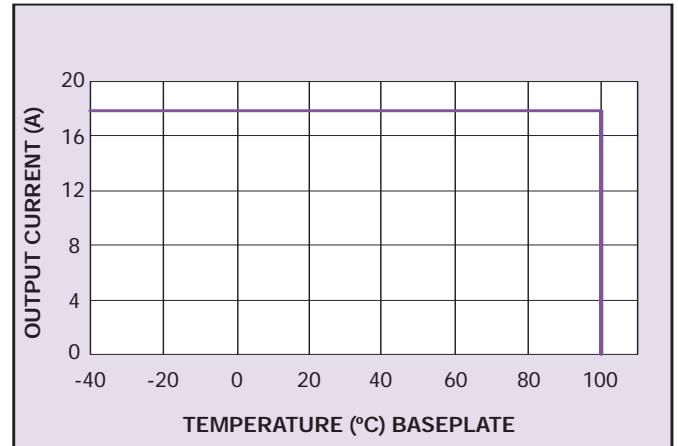

Figure 2 - RFF500 Derating Curve

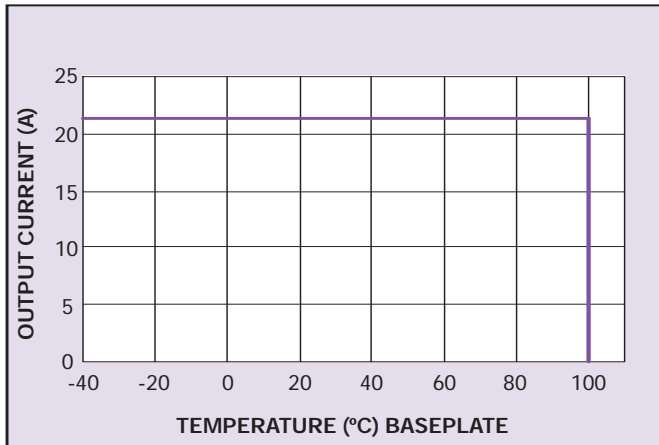

Figure 3 - RFF600 Derating Curve

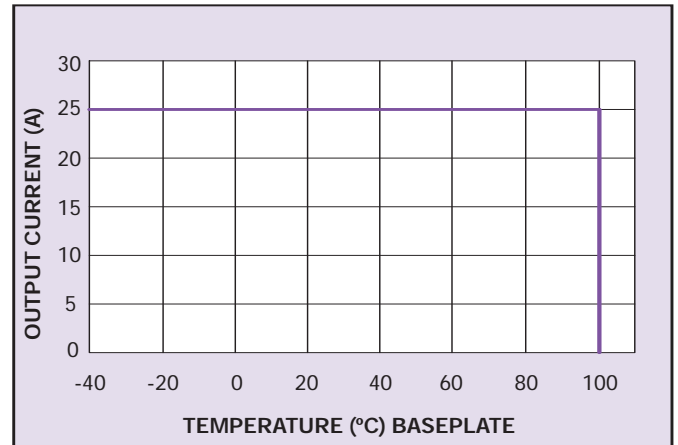

Figure 4 - RFF700 Derating Curve

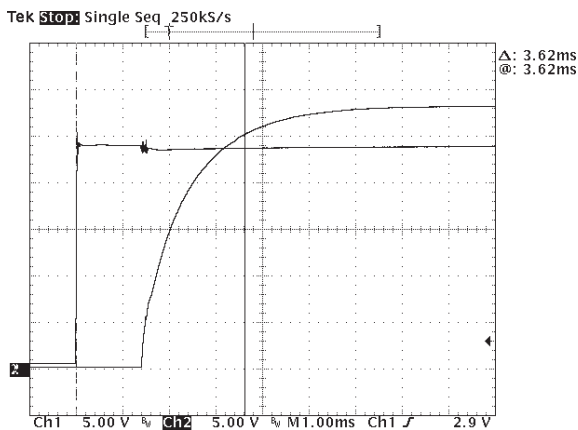

Figure 5 - Typical Turn-on Delay and Risettime RFF600-24S28Y  
Channel 1: Input Voltage, Channel 2: Output Voltage

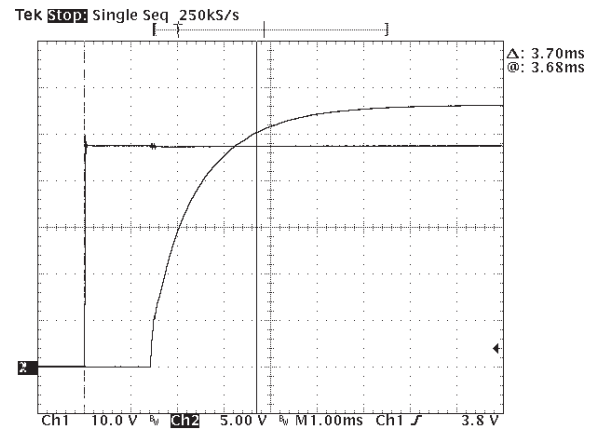

Figure 6 - Typical Turn-on Delay and Risettime RFF700-48S28Y  
Channel 1: Input Voltage, Channel 2: Output Voltage

# RFF500/600/700 Series

## 24 Vin and 48 Vin single output

DC-DC CONVERTERS 500 W, 600 W and 700 W Full-Brick

4

For the most current data and application support visit [www.artesyn.com/powergroup/products.htm](http://www.artesyn.com/powergroup/products.htm)

NEW Product

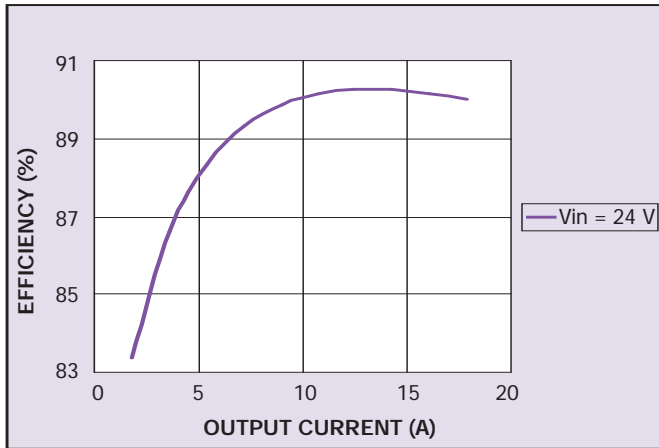

Figure 7 - Typical Efficiency vs. Output Current – RFF500-24S28Y

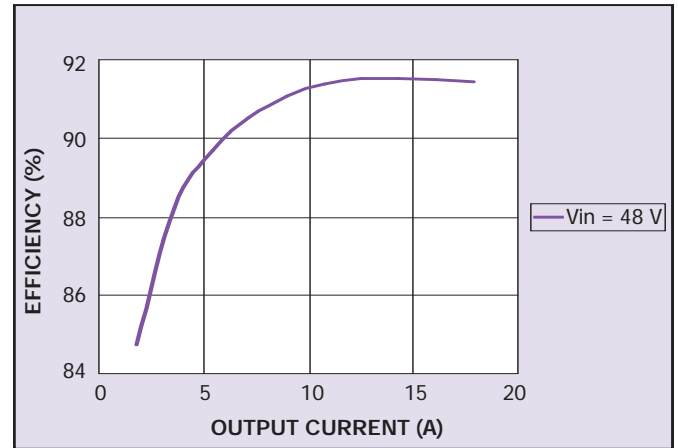

Figure 8 - Typical Efficiency vs. Output Current – RFF500-48S28Y

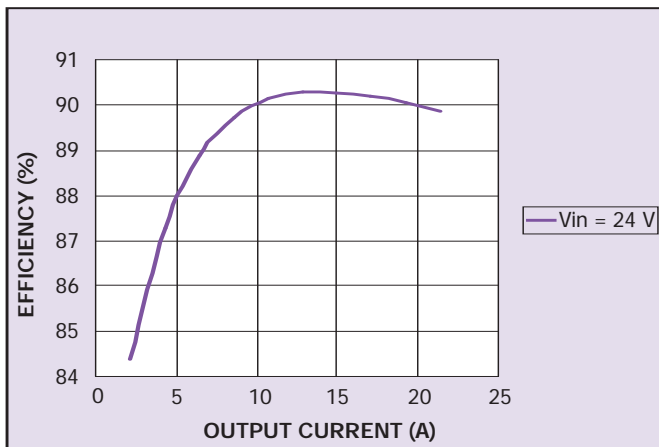

Figure 9 - Typical Efficiency vs. Output Current – RFF600-24S28Y

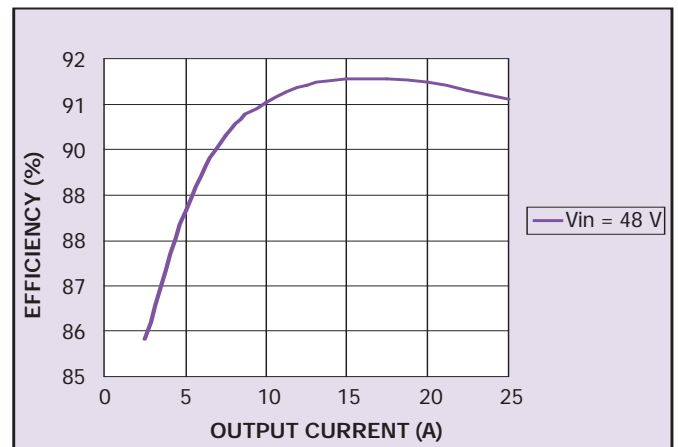

Figure 10 - Typical Efficiency vs. Output Current – RFF700-48S28Y

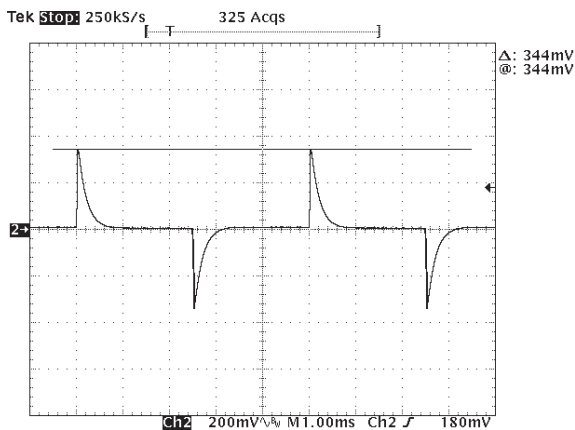

Figure 11 - RFF600-24S28Y Transient Response  
Load 10.70 A to 16.05 A

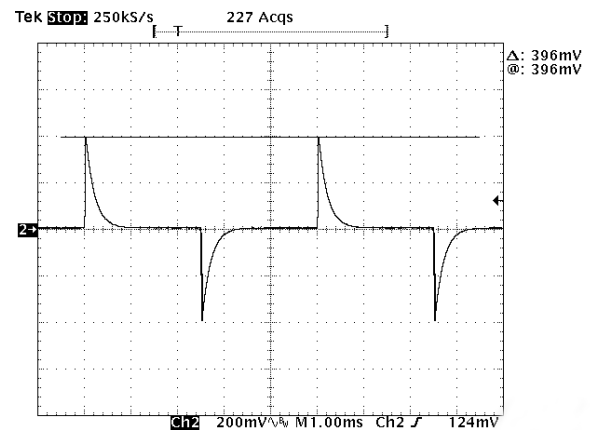

Figure 12 - RFF700-48S28Y Transient Response  
Load 12.5 A to 18.75 A

# RFF500/600/700 Series

24 Vin and 48 Vin single output

DC-DC CONVERTERS | 500 W, 600 W and 700 W Full-Brick

5

For the most current data and application support visit [www.artesyn.com/powergroup/products.htm](http://www.artesyn.com/powergroup/products.htm)

NEW Product

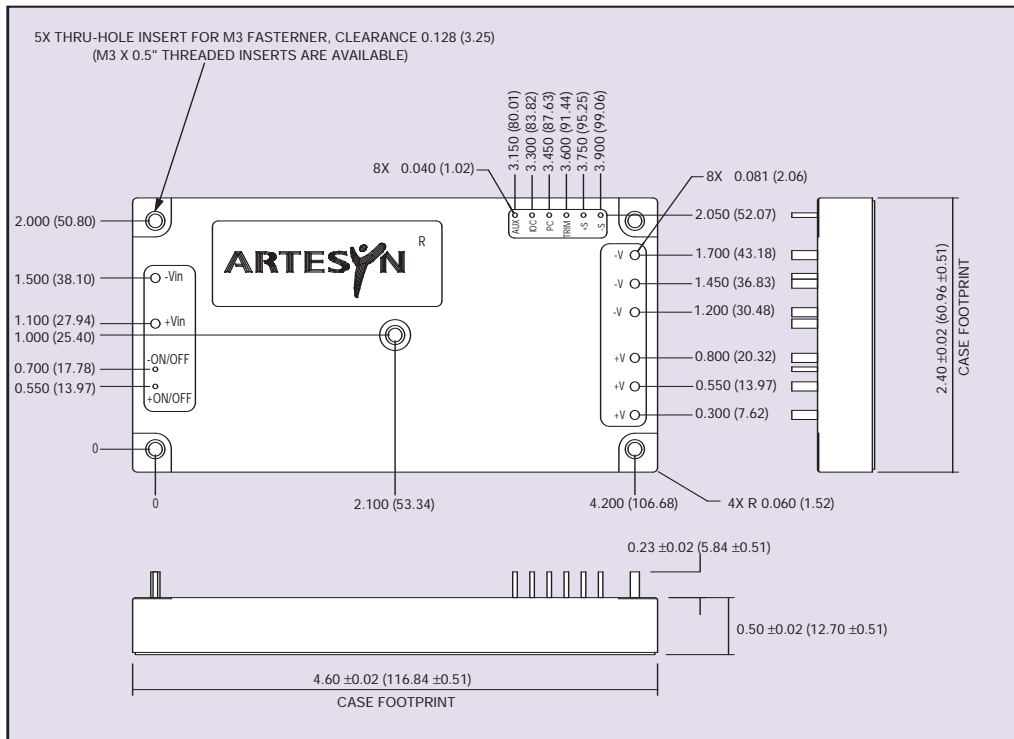

## PIN CONNECTIONS

PIN NUMBER	FUNCTION
-Vin	Negative Input Terminal
+Vin	Positive Input Terminal
-ON/OFF	Negative Input Remote ON/OFF
+ON/OFF	Positive Input Remote ON/OFF
-V	Negative Output Terminals
+V	Positive Output Terminals
Aux	Auxiliary Power Terminal
IOC	Inverter Operation Good
PC	Parallel Control Pin
TRIM	Output Adjustment Trim Pin
+S	Positive Remote Sense
-S	Negative Remote Sense

Figure 13 - Mechanical Drawing and Pin-Out Table

Datasheet © Artesyn Technologies® 2006

The information and specifications contained in this datasheet are believed to be correct at time of publication. However, Artesyn Technologies accepts no responsibility for consequences arising from printing errors or inaccuracies. The information and specifications contained or described herein are subject to change in any manner at any time without notice. No rights under any patent accompany the sale of any such product(s) or information contained herein.

Please consult our website for the following items: ✓ Application Note

[www.artesyn.com](http://www.artesyn.com)